

maximum

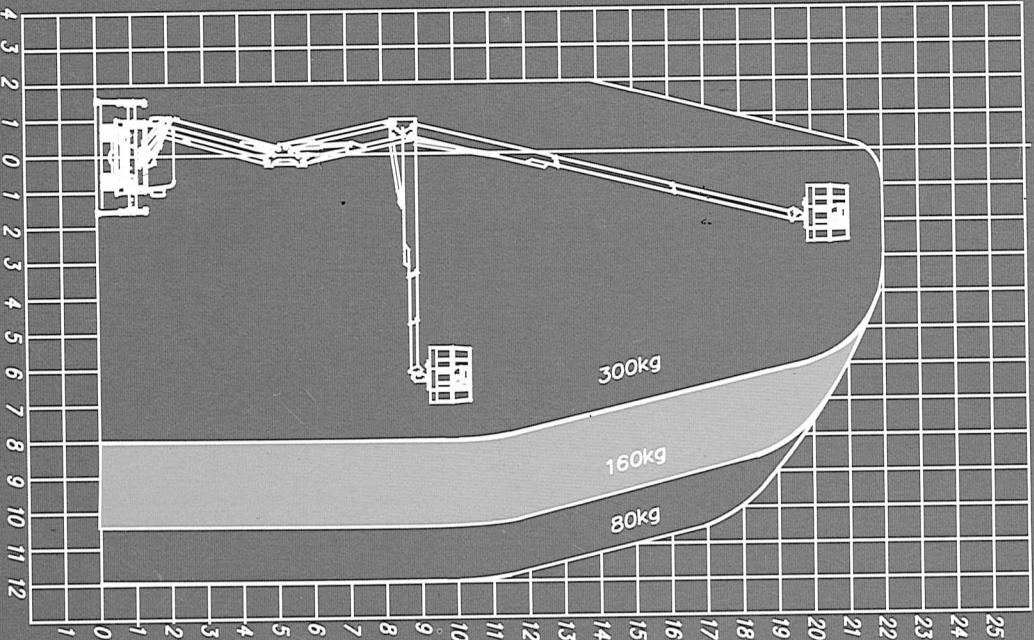

medium

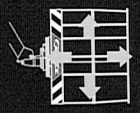
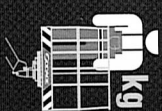
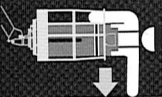
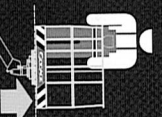
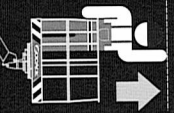
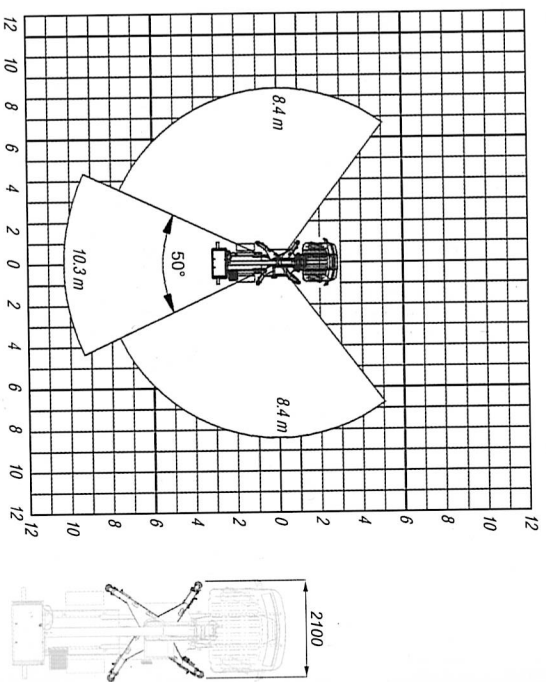
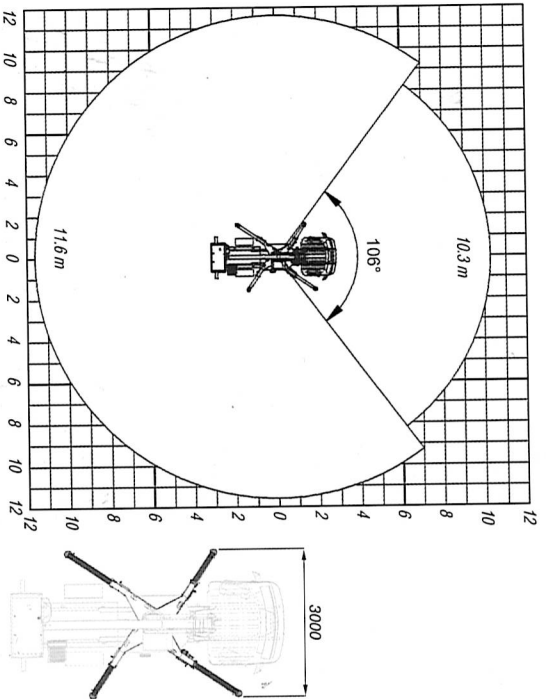
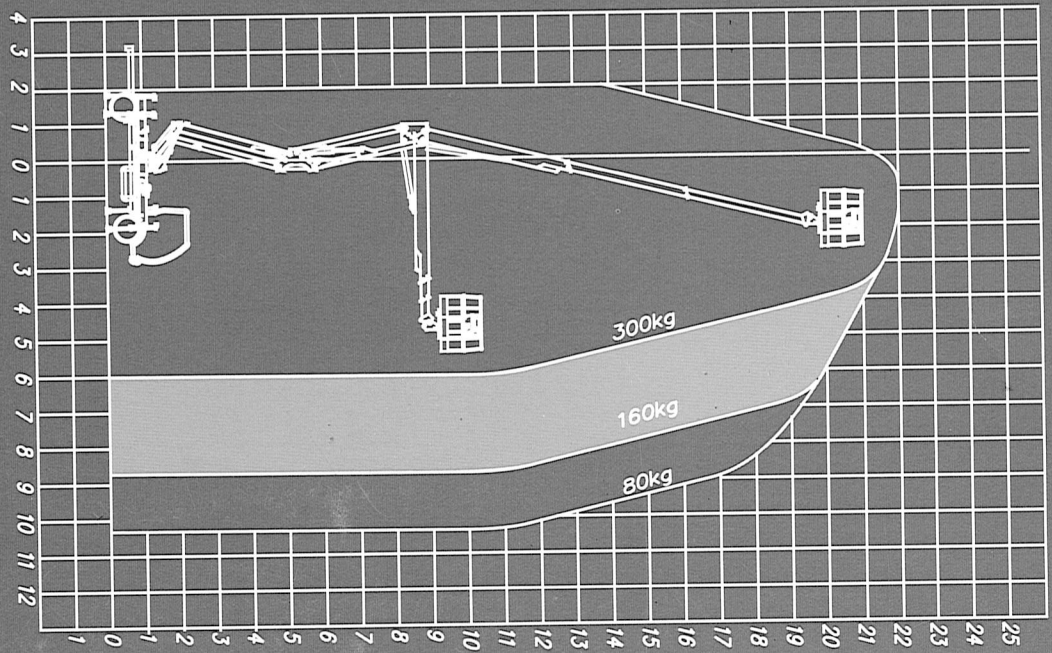

22,00 m

20,00 m

12,00 m

300 kg

1,4x0,7x1,1 m

minimum

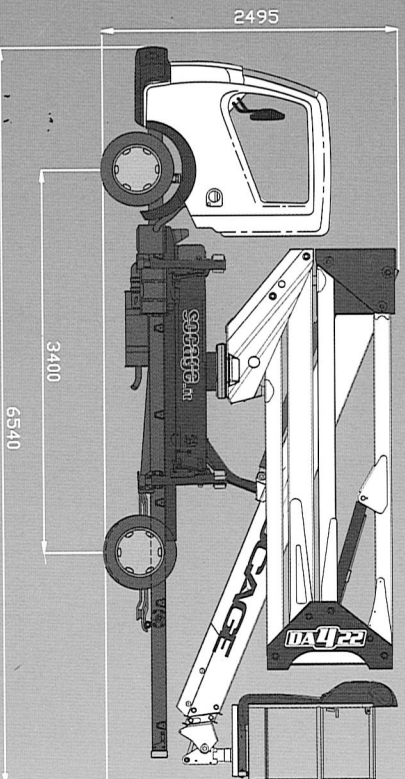
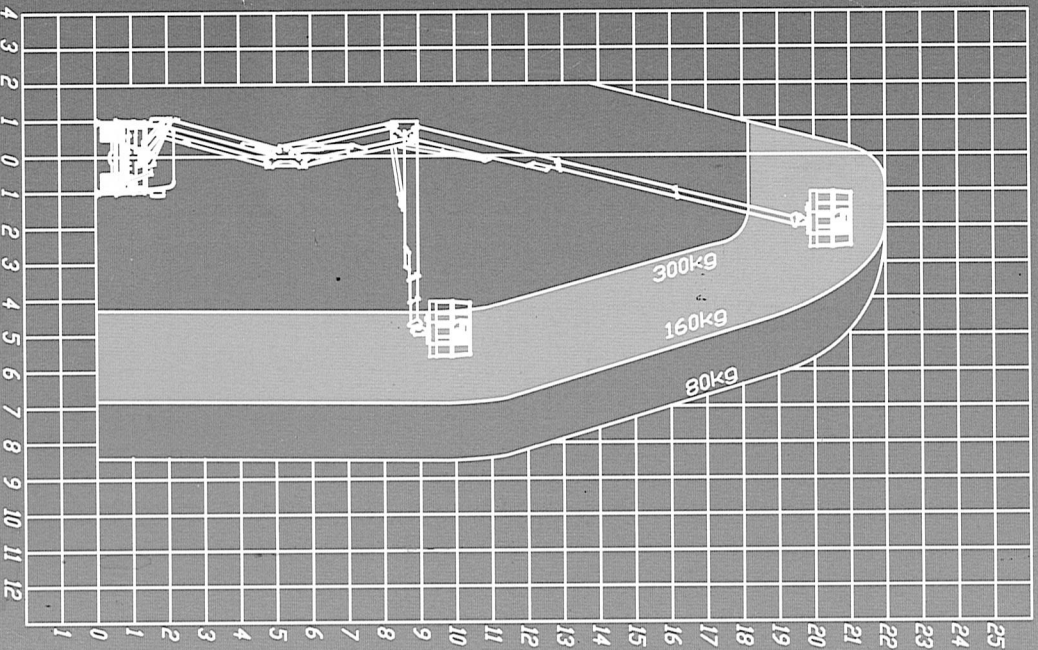

DA 4222
portable
X
FACTOR

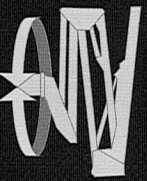
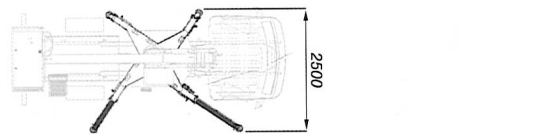
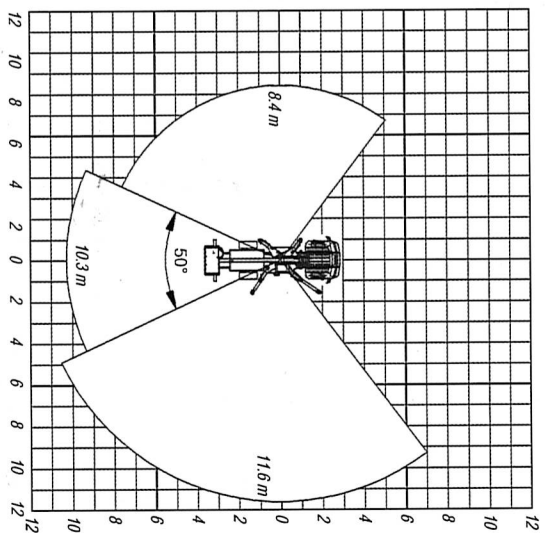
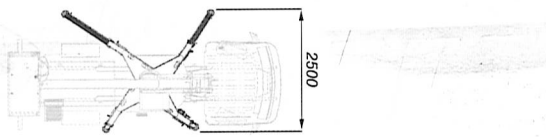
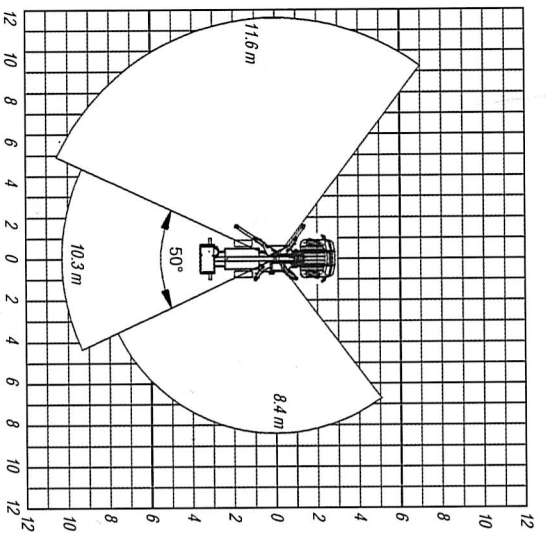

700°

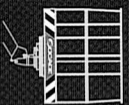

aluminium



90°+90°



ME+ME

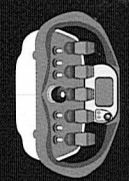

Hydraulic